



Community Microgrids: The Path to Resilience & Sustainability

Greg Thomson
Director, Community Microgrid Initiative
Clean Coalition
415-845-3872 mobile
greg@clean-coalition.org

Energy is critical infrastructure.

And yet, our legacy, centralized energy architecture carries multiple critical risks.

- This architecture is **costly, aging, inefficient**, and a **highly vulnerable security risk**
- **Extreme weather events** are occurring more frequently, further demonstrating the **vulnerability** and **high cost**
- **Cyber attacks** are a **growing risk**, and an attack on a centralized system can **affect millions**
- To accomplish both **local and national security**, we must move more quickly to a new solution

**Community Microgrids:
Cleaner, More Reliable & Resilient, More Affordable**

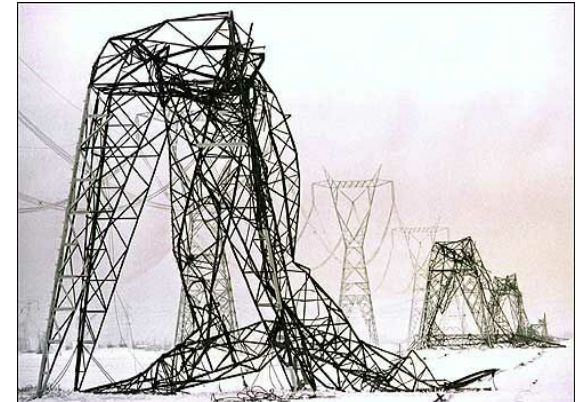

Traditional Microgrids focus on single customers

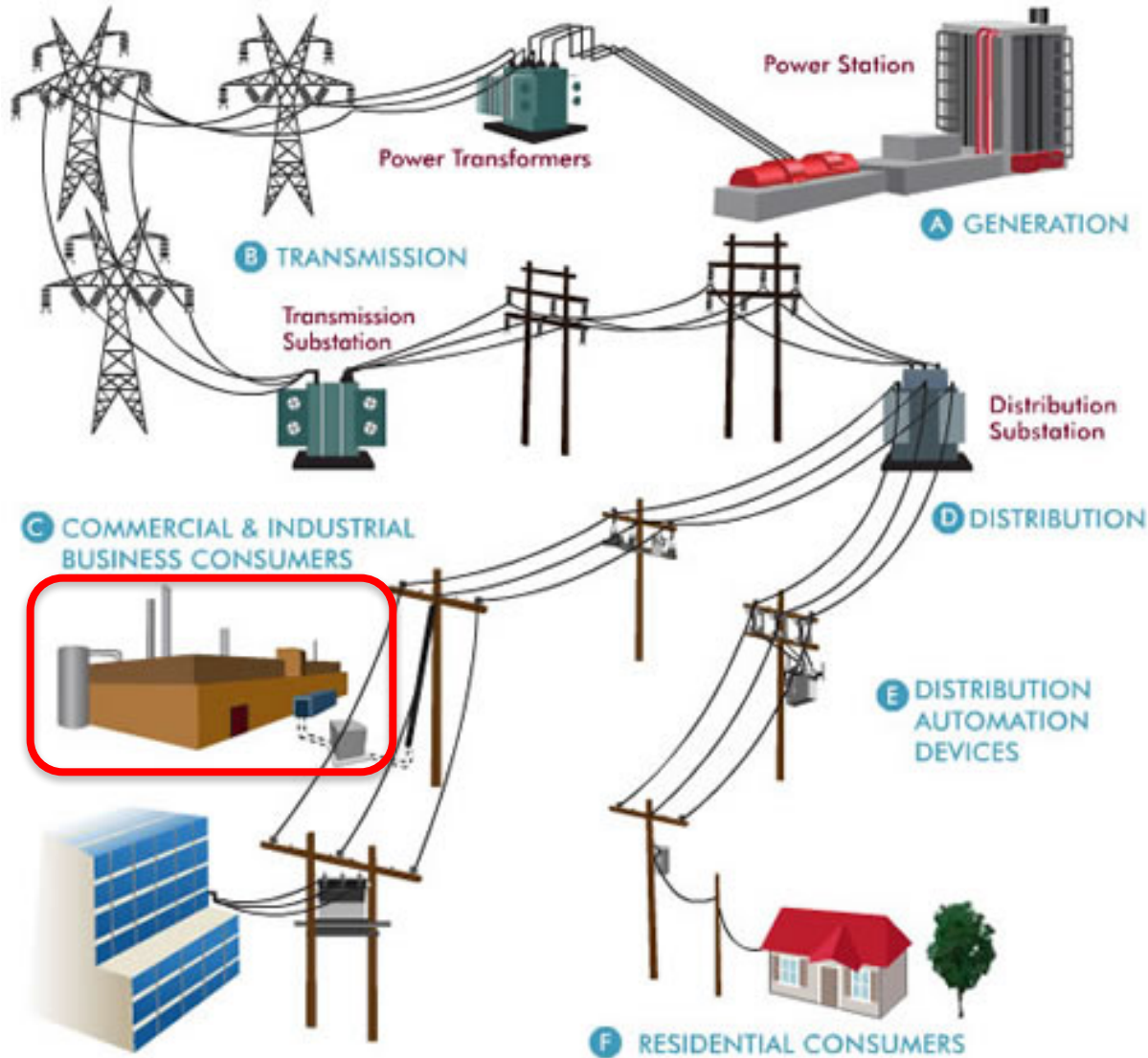

Source: Oncor Electric Delivery Company

Community Microgrids serve thousands of customers

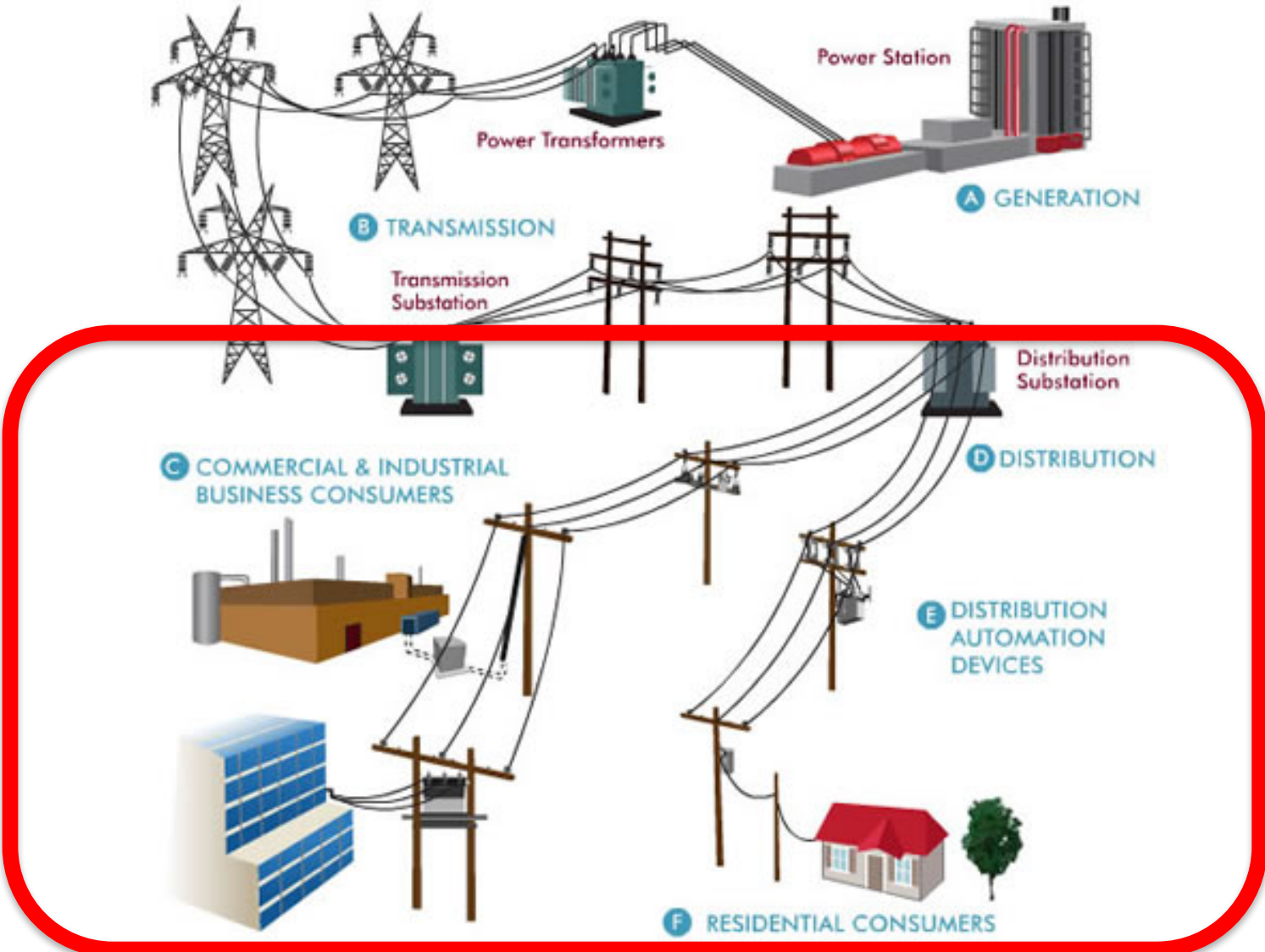

Source: Oncor Electric Delivery Company

A Community Microgrid is a new approach for designing and operating the electric grid, stacked with local renewables and staged for resilience.

Key features:

- A targeted and coordinated local grid area served by one or more distribution substations
- High penetrations of local renewables and other Distributed Energy Resources (DER) such as energy storage and demand response
- Staged capability for ongoing renewables-driven power backup for critical and prioritized loads across the grid area
- A solution that can be readily extended throughout a utility service territory – and replicated into any utility service territory around the world



- Local Balancing as a system solution for the grid analyzes the load amounts and load shapes at each substation
- Based on this analysis, we can determine the optimal load shape (flatter) and load amount (lower) for each substation, thus reducing system wide costs and inefficiencies
- Based on local resources, DER is integrated into the substation plan specifically to achieve the desired flatter load shape and reduced load amounts, while also adding local resilience and energy security at critical & desired locations
- The substation becomes a combined load & generation ecosystem – a local balancing solution – that reduces remote grid costs while simultaneously strengthening the local grid

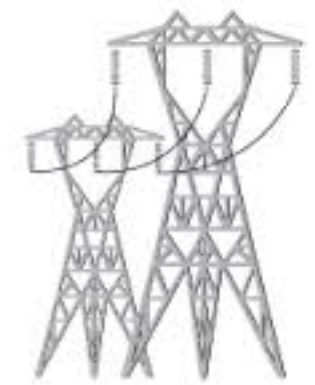

The six economic benefits of Local Balancing via Community Microgrids

1. **Cost Reductions Due to *Peak Management***: Protection against the high cost of peak energy
2. **Cost Reductions Due to *Demand Charges***: Protection against additional fees charged by utilities for peaks
3. **Cost Reductions Due to *Rate Management***: Protection against future rate changes, e.g. evening ramp
4. **Cost Reductions Due to *Investment Deferrals***: Deferral of substantial costs for centralized infrastructure
5. **Cost Certainty**: Keeping rates and costs constant for consumers as well as grid operators.
6. **Increased Economic Investment in Communities**



These Cost Issues Are Caused by Our Mostly Centralized System

Local Balancing optimizations

Optimal locations for PV, to help reduce daytime peaks across the system:

1. Matching load types: e.g. higher loads during daytime means better match for PV
2. Robust feeder locations: less resistance (lower Ohms) means more capacity for local generation
3. Avoided costs: service transformers, etc.

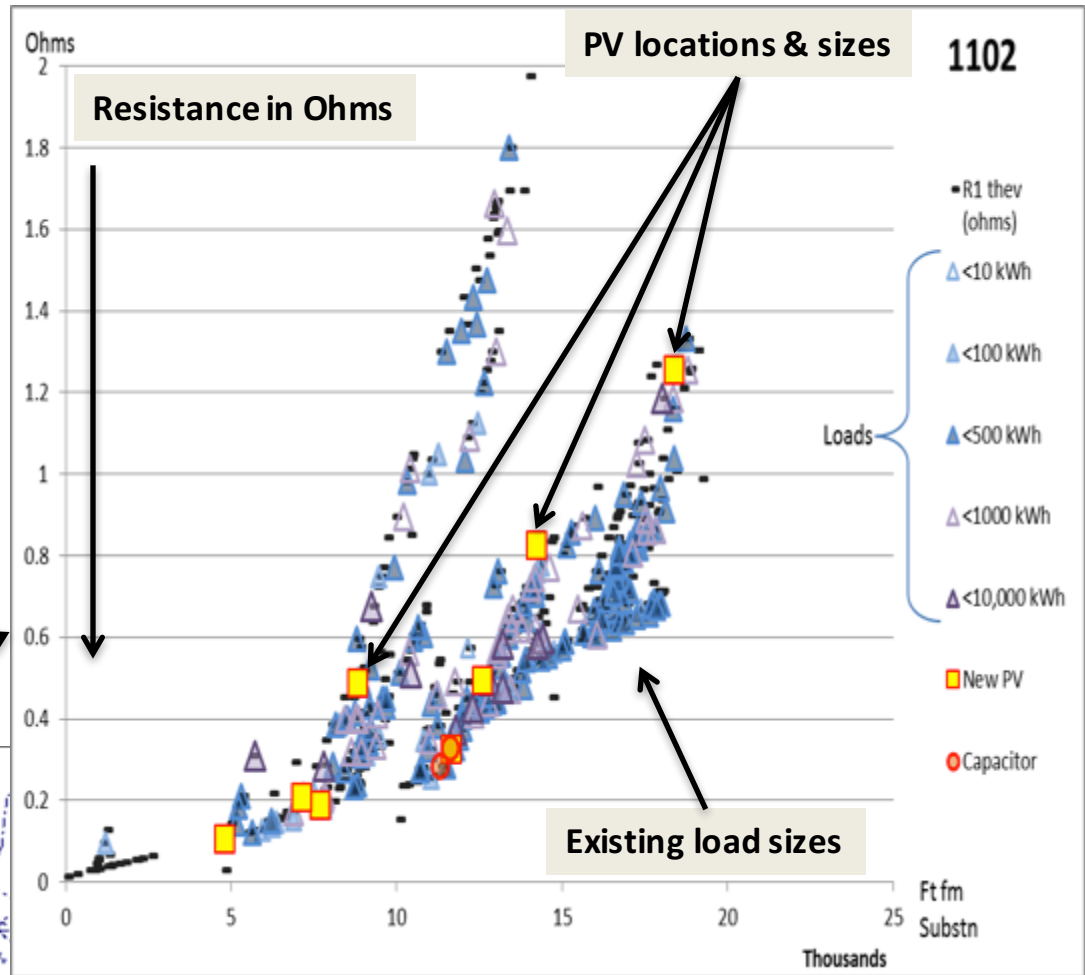

Feeder map based on resistance (Ohms)

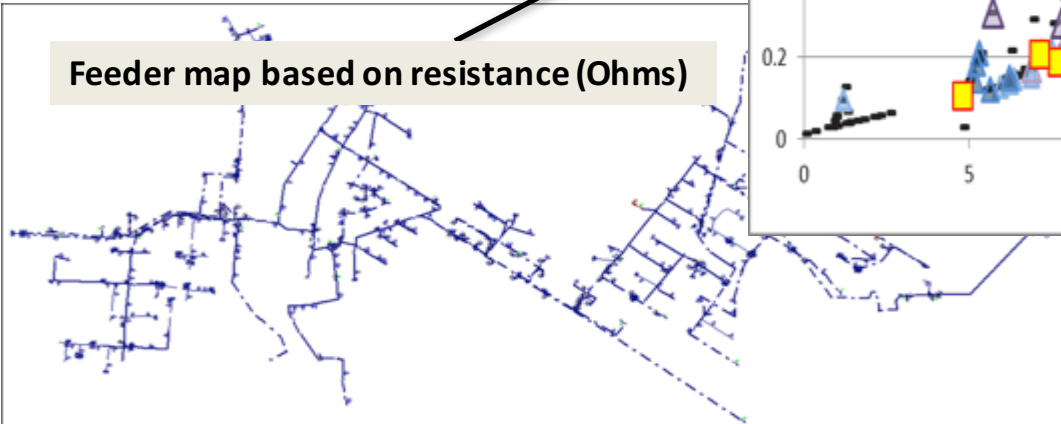

Opportunity: Vastly Untapped Commercial & Industrial Energy Assets

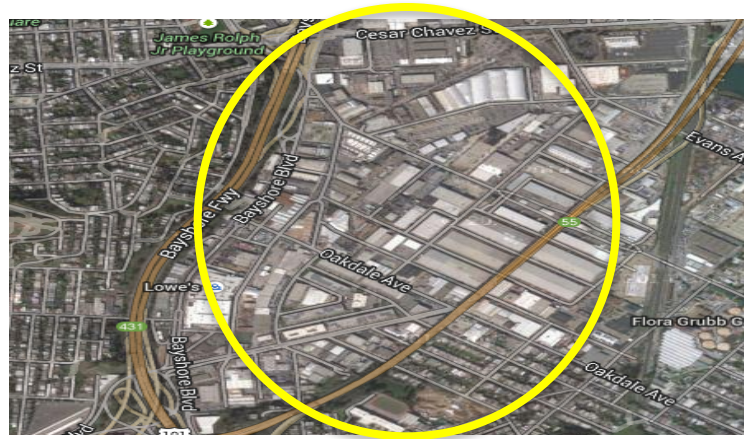

The formula for low carbon cities:

Example: solar on 25% of C&I rooftops = 25%+ local annual energy use

- ✓ Largest financial opportunity – largest DER systems
- ✓ Largest rooftops & parking lots – most generation
- ✓ Largest daytime loads – matching solar
- ✓ Largest utility bills incl. demand charges – motivated
- ✓ Best solution for grid – system peak reduction, strong feeders
- ✓ Most carbon emissions within cities

Connected feeders enables substation-wide optimizations and balancing across a substation, such as:

1. “Crossfeeding,” e.g. over-generation on certain feeders consumed by load on other feeders within the substation area
2. Optimizing DER such as storage and demand response across the substation feeders
3. Optimizing settings, e.g. load tap changers, across the substation feeders

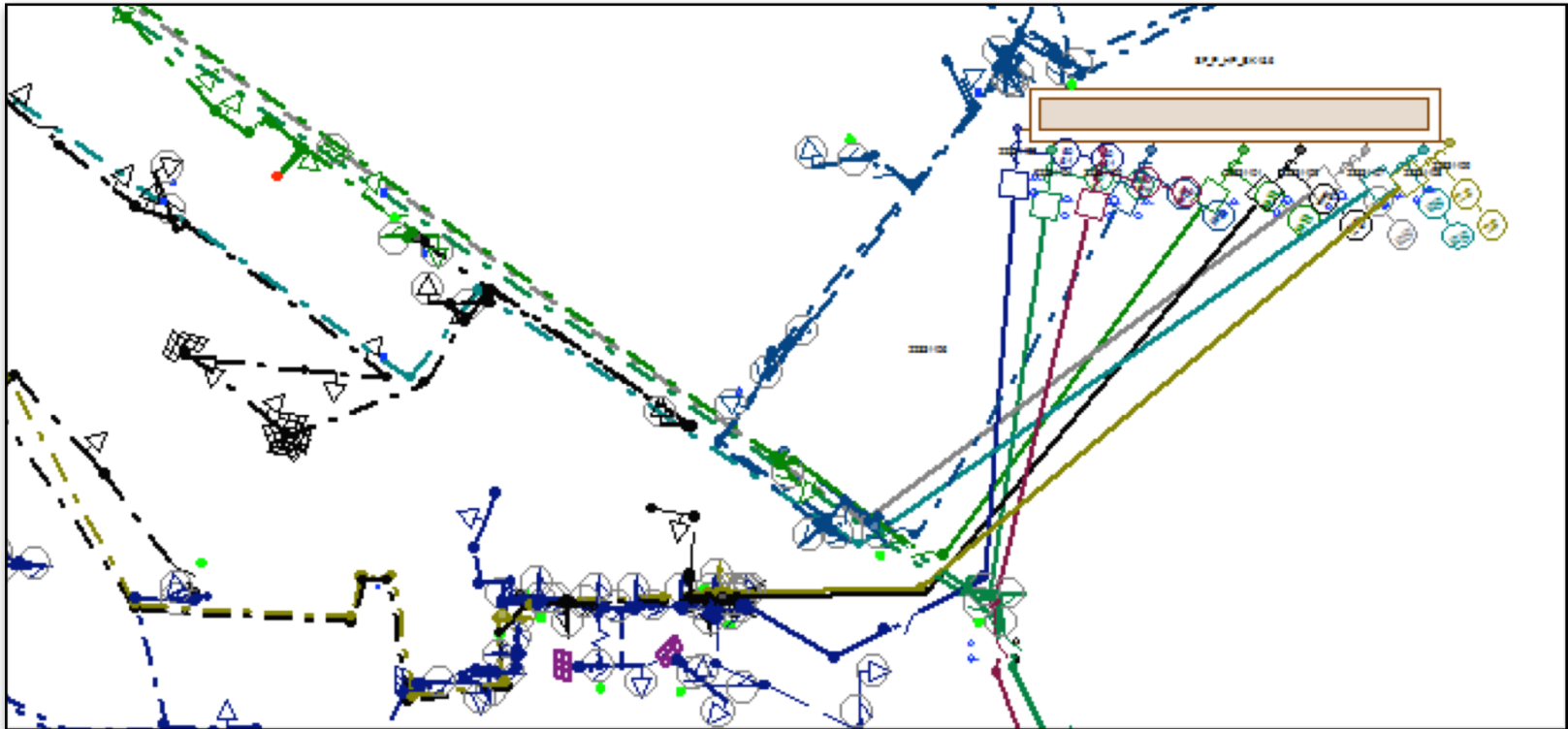

Long Island Community Microgrid Design

- The LICMP would **avoid \$29-38 Million** of new transmission capacity resulting in a net cost benefit for all ratepayers.
- The combined Solar + Storage system would also **reduce NYISO capacity charges by \$6 Million** through 2022, and at a rate exceeding \$1 Million annually thereafter.
- The system would also shift wholesale power purchases from peak to off peak periods, realizing **net energy savings of \$2.5 Million** by 2022 and more than \$500,000 annually thereafter.
- Resiliency savings from avoided outages would **exceed \$330,000** per outage day
- These savings would be reflected in **lower electric rates** for all PSEG-LI utility customers.



Long Island Community Microgrid Design

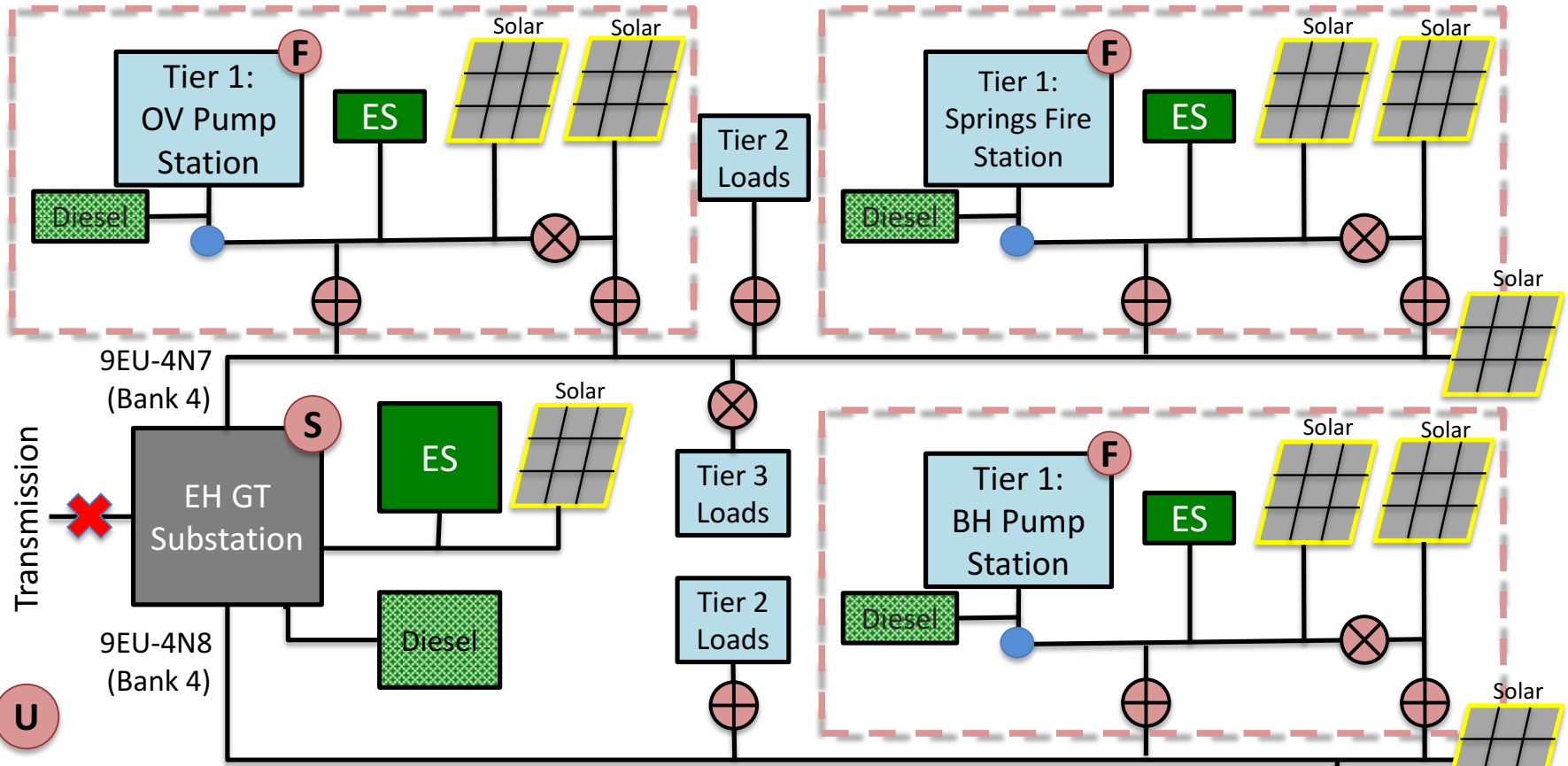

U

ISO

MC² Control Level

- F** Facility, autonomous capable
- S** Substation, autonomous capable
- U** Utility
- ISO** Independent System Operators

Other Diagram Elements

- Autonomously Controllable Microgrid
- Relay/Switch (open, closed)
- Meter

Area 1: Coffey Park and the Bicentennial Corridor – ideal for Community Microgrid

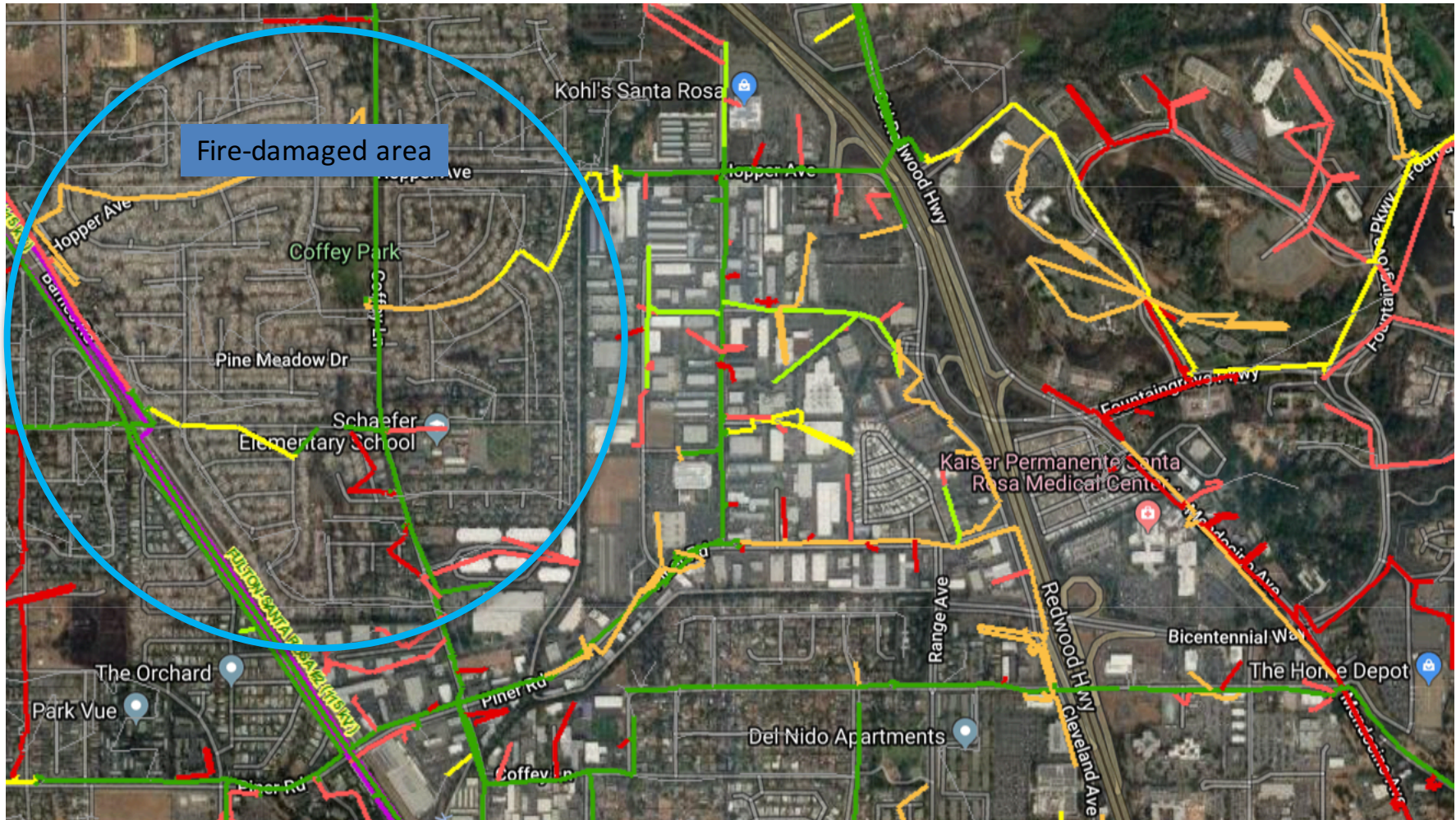

Area 2: Larkfield and the Old Redwood Highway Corridor – ideal for Community Microgrid

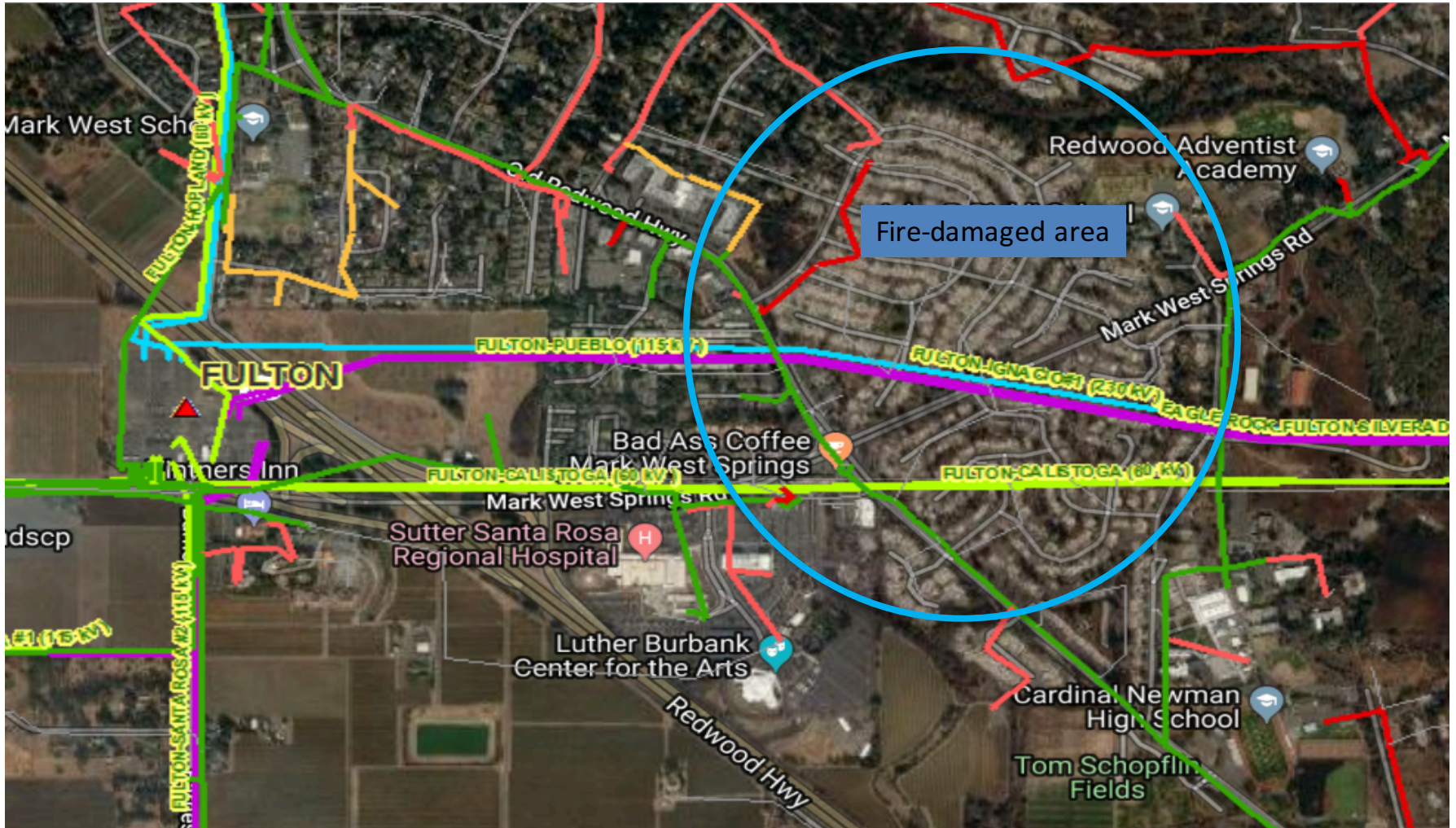

Objective: make energy abundant, affordable, resilient, and sustainable

- 1) **Re-build fire-destroyed areas with high levels of resilience and sustainability** in both the building stock and the grid, enabling a modern, distributed, and carbon free system that delivers substantial economic, environmental, and resilience benefits.
- 2) **Establish a blueprint for re-building disaster-destroyed areas** in a timely and cost-effective manner that also maximizes the economic and resilience value of energy as a critical resource to ratepayers, property owners, and municipalities.
- 3) **Provide a model for operating a modern distribution grid** covering an entire substation area that incorporates optimal distributed energy resources, cost-effective local balancing, full interaction with the transmission system, and local energy markets – with resulting benefits across both grid operations and economics.
- 4) **Ensure that building codes are advanced** to achieve more resilient, safer, and cleaner building stock and communities.

